



Application Note: SY8286A

High Efficiency Fast Response 6A, 23V Input Synchronous Step Down Regulator

General Description

The SY8286A develops a high efficiency synchronous step-down DC-DC regulator capable of delivering 6A current. The device integrates main switch and synchronous switch with very low $R_{DS(ON)}$ to minimize the conduction loss.

The SY8286A operates over a wide input voltage range from 4V to 23V. The DC-DC regulator adopts the instant PWM architecture to achieve fast transient responses for high step down applications and high efficiency at light load. The device provides various protection features for reliable operation. In addition, it operates at pseudo-constant frequency of 600kHz to minimize the size of inductor and capacitor.

Ordering Information

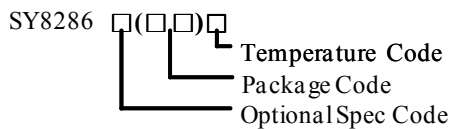

Ordering Number	Package type	Note
SY8286ARAC	QFN3x3-20	--

Features

- Low $R_{DS(ON)}$ for internal switches (top/bottom): 38/19 m Ω
- Wide input voltage range: 4-23V
- Instant PWM architecture to achieve fast transient responses
- Internal 1.3ms soft-start limits the inrush current
- Pseudo-constant frequency: 600kHz.
- 6A output current capability
- +/-1% internal reference voltage
- PFM/PWM selectable light load operation mode
- Optional bypass input
- Power good indicator
- Output discharge function
- Output current limit protection
- Hiccup mode output short circuit protection
- Output over voltage protection
- Input UVLO
- Over temperature protection with auto recovery
- RoHS Compliant and Halogen Free
- Compact package: QFN3x3-20

Applications

- LCD-TV/Net-TV/3DTV
- Set Top Box
- Notebook
- High Power AP

Typical Applications

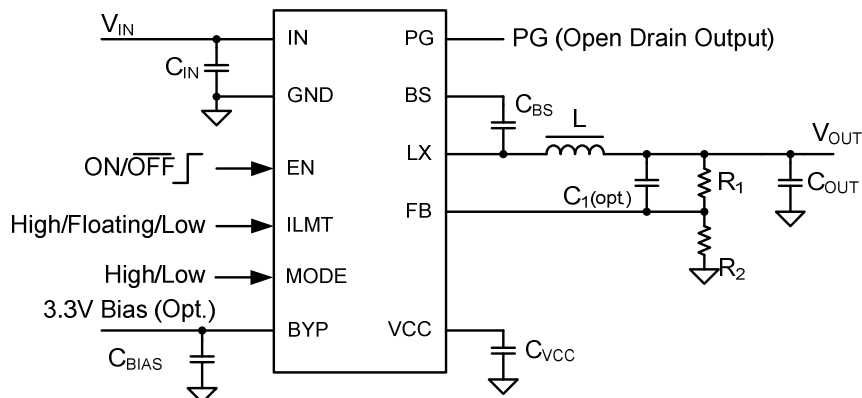
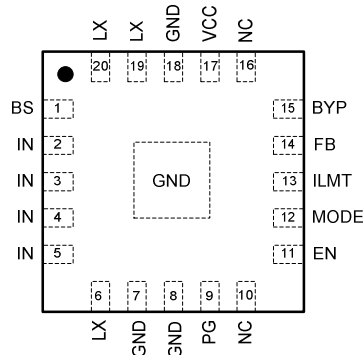

Figure 1 Schematic



Pinout (top view)



(QFN3x3-20)

Top Mark: AWR_{xyz}, (Device code: AWR, *x*=year code, *y*=week code, *z*=lot number code)

Pin Name	Pin Number	Pin Description
BS	1	Boot-strap pin. Supply high side gate driver. Decouple this pin to LX pin with 0.1uF ceramic capacitor.
IN	2,3,4,5	Input pin. Decouple this pin to GND pin with at least 10uF ceramic cap
LX	6,19,20	Inductor pin. Connect this pin to the switching node of inductor
GND	7,8,18,EP	Ground pin
PG	9	Power good Indicator. Open drain output when the output voltage is within 90% to 120% of regulation point.
NC	10, 16	Not connected
EN	11	Enable pin. Pull this pin high to turn on IC. Do not leave this pin floating.
MODE	12	Operating mode selection under light load. Pull this pin low for PFM operating, and pull this pin high for PWM operation. Do not leave this pin floating
ILMT	13	Output current limit threshold selection.
FB	14	Output feedback pin. Connect to the center point of resistor divider.
BYP	15	External 3.3V bypass power supply input. Decouple this pin to GND with a 1uF ceramic capacitor. Leave this pin floating if it is not used.
VCC	17	Internal 3.3V LDO output. Power supply for internal analog circuits and driving circuit. Decouple this pin to GND with a 2.2uF ceramic capacitor.

Block Diagram

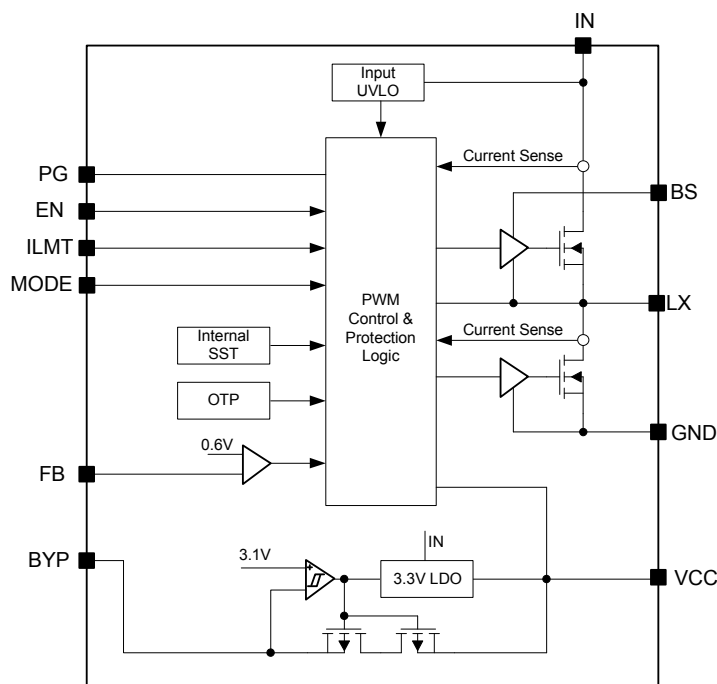

Absolute Maximum Ratings (Note 1)

IN	-----	25V
BS-LX	-----	4V
EN, ILMT, MODE, PG, LX	-----	25V
VCC, FB	-----	4V
BYP	-----	6V
Power Dissipation,		
$P_D @ T_A = 25^\circ\text{C}$ QFN3x3-20	-----	3.3W
Package Thermal Resistance (Note 2)		
θ_{JA} , QFN3x3-20	-----	30°C/W
θ_{JC} , QFN3x3-20	-----	4.5°C/W
Junction Temperature Range	-----	150°C
Lead Temperature (Soldering, 10 sec.)	-----	260°C
Storage Temperature Range	-----	-65°C to 150°C
Dynamic LX voltage in 10ns duration	-----	IN+3V to GND-5V

Recommended Operating Conditions (Note 3)

Supply Input Voltage	-----	4V to 23V
Junction Temperature Range	-----	-40°C to 125°C
Ambient Temperature Range	-----	-40°C to 85°C



Electrical Characteristics

(V_{IN} = 12V, T_A = 25°C unless otherwise specified)

Parameter	Symbol	Test Conditions	Min	Typ	Max	Unit
Input Voltage Range	V _{IN}		4		23	V
Input UVLO Threshold	V _{UVLO}	V _{IN} Rising			3.9	V
UVLO hysteresis	V _{HYS}			0.1		V
Quiescent Current	I _Q	I _{OUT} =0, V _{OUT} =V _{SET} *105%		120	145	μA
Shutdown Current	I _{SHDN}	EN=0,		6	10	μA
Feedback Reference Voltage	V _{REF}		0.594	0.6	0.606	V
Top FET RON	R _{DS(ON)1}			38		mΩ
Bottom FET RON	R _{DS(ON)2}			19		mΩ
Output Discharge Current	I _{DIS}			70		mA
Top FET Current Limit	I _{LMT,HSFET}			17		A
Bottom FET Current Limit	I _{LMT,LSFET}	ILMT=Low	6.7	7.8	8.9	A
		ILMT=Floating	9.3	10.6	11.9	A
		ILMT=High	12	13.3	14.8	A
Soft Start Time	t _{SS}			1.3		ms
EN/MODE Rising Threshold	V _{ENH}		1			V
EN/MODE Falling Threshold	V _{ENL}				0.4	V
ILMT Rising Threshold	V _{ILMTH}		V _{CC} -0.5			V
ILMT Falling Threshold	V _{ILMTL}				0.5	V
Switching Frequency	F _{OSC}		510	600	690	kHz
Min ON Time	T _{ON,MIN}	V _{IN} =V _{INMAX}		50		ns
Min OFF Time	T _{OFF,MIN}			150		ns
VCC Output Voltage	V _{CC}	With 1mA Load	3.2	3.3	3.4	V
Output Over Voltage Threshold	V _{OVP}	V _{FB} Rising	115	120	125	%V _{REF}
Output Over Voltage Hysteresis	V _{OVP,HYS}			1.5		%V _{REF}
Output OVP Delay	t _{OVP,DLY}			20		μs
Output Under Voltage Protection Threshold	V _{UVP}	V _{FB} Falling	57.5	62.5	67.5	%V _{REF}
Output UVP Delay	t _{UVP,DLY}			200		us
Power Good Threshold	V _{PG}	V _{FB} Rising (Good)		92		%V _{REF}
Power Good Hysteresis	V _{PG,HYS}			1.5		%V _{REF}
Power Good Delay	t _{PG,RISING}	Low to high		200		μs
	t _{PG,FALLING}	High to low		10		μs
Bypass Switch Turn-on Voltage	V _{BYP}		2.97	3.1	3.21	V
Bypass Switch Switchover Hysteresis	V _{BYP,HYS}			0.15		V
Bypass Switch OVP	V _{BYP,OVP}			120		%V _{CC}
Thermal Shutdown Temperature	T _{SD}			150		°C
Thermal Shutdown hysteresis	T _{HYS}			15		°C

Note 1: Stresses beyond the “Absolute Maximum Ratings” may cause permanent damage to the device. These are stress ratings only. Functional operation of the device at these or any other conditions beyond those indicated in the



operational sections of the specification is not implied. Exposure to absolute maximum rating conditions for extended periods may affect device reliability

Note 2: Package thermal resistance is measured in the natural convection at $T_A = 25^\circ\text{C}$ on a four-layer Silergy Evaluation Board.

Note 3: The device is not guaranteed to function outside its operating conditions.

Typical Performance Characteristics

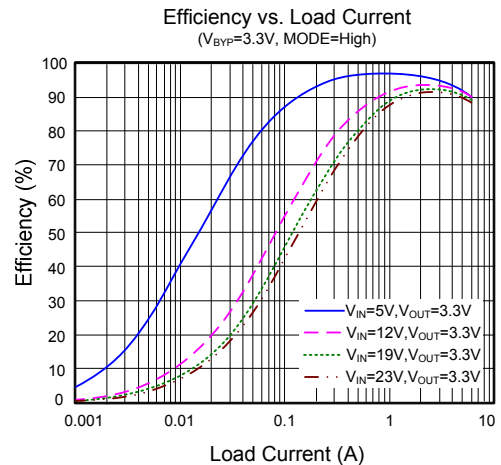
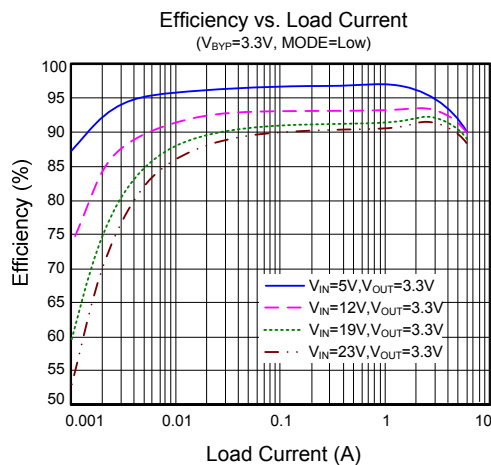
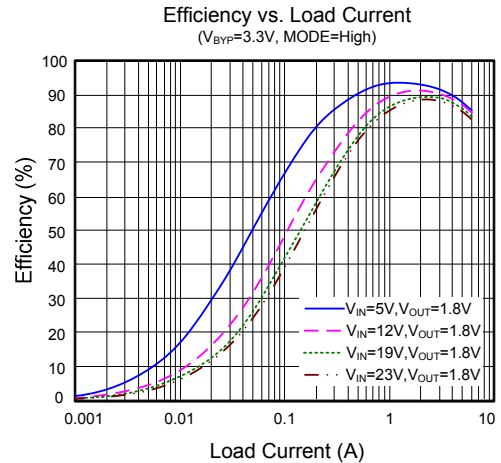
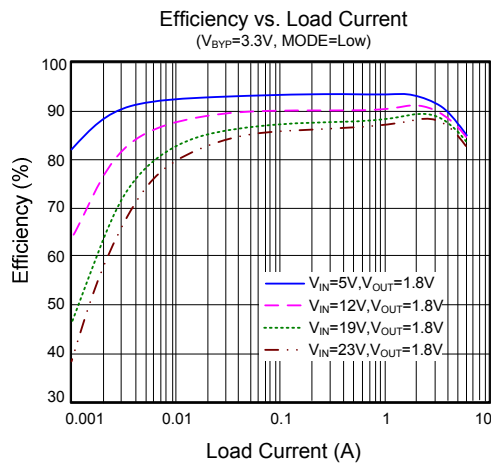
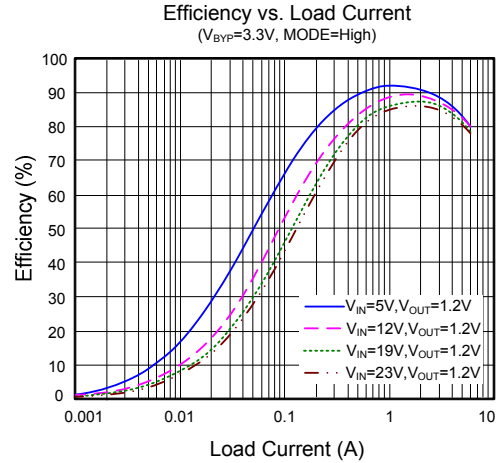
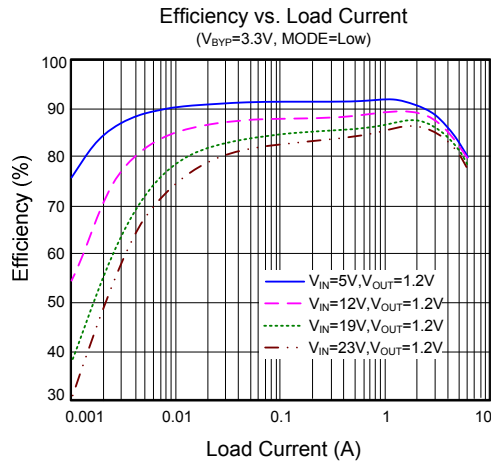



Efficiency vs. Load Current
 ($V_{BYP}=3.3V$, MODE=Low)

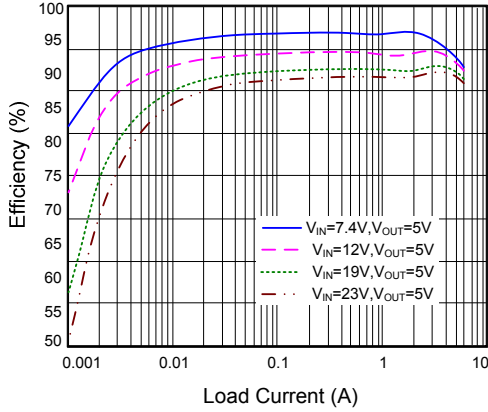

Efficiency vs. Load Current
 ($V_{BYP}=3.3V$, MODE=High)

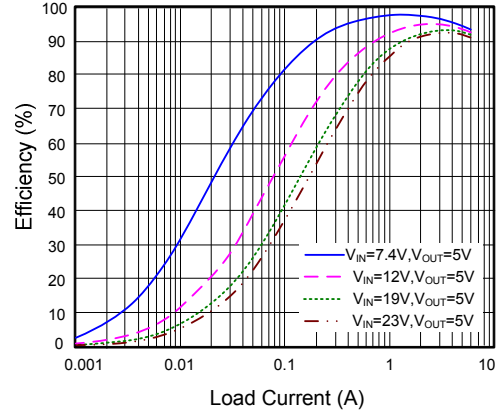

Load Regulation
 ($V_{BYP}=3.3V$, MODE=Low)

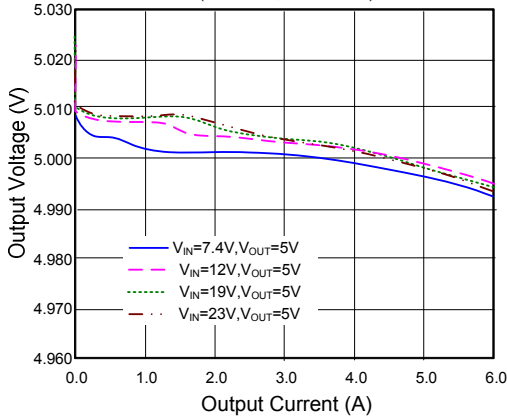

Load Regulation
 ($V_{BYP}=3.3V$, MODE=High)

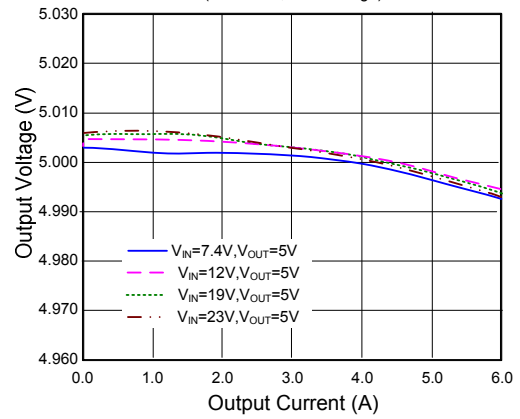

Line Regulation
 ($V_{BYP}=3.3V$, MODE=Low)

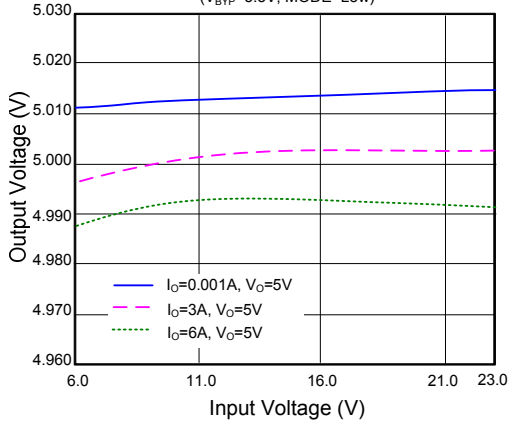

Line Regulation
 ($V_{BYP}=3.3V$, MODE=High)

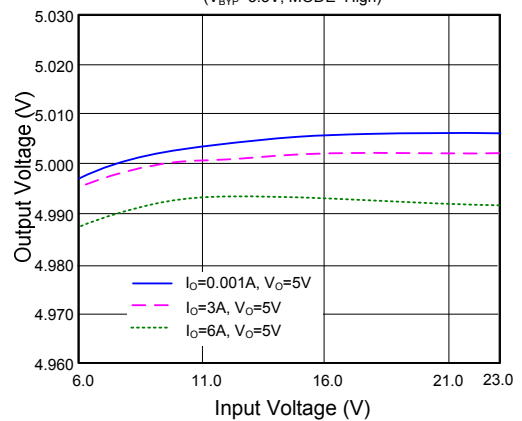

Load Transient

($V_{IN}=12V$, $V_{OUT}=3.3V$, $I_{OUT}=0.6-6A$, MODE=Low)

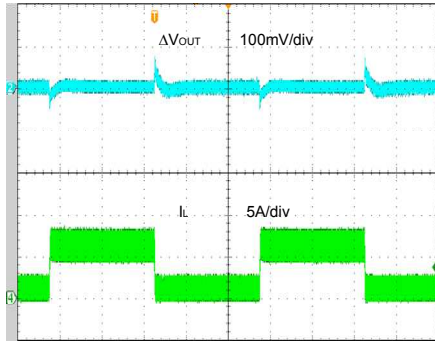

Time (200μs/div)

Load Transient

($V_{IN}=12V$, $V_{OUT}=3.3V$, $I_{OUT}=0.6-6A$, MODE=High)

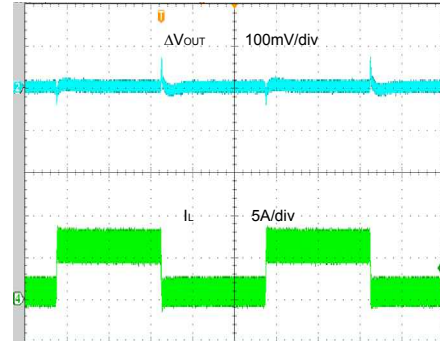

Time (200μs/div)

Output Ripple

($V_{IN}=12V$, $V_O=3.3V$, $I_O=0A$, MODE=Low)

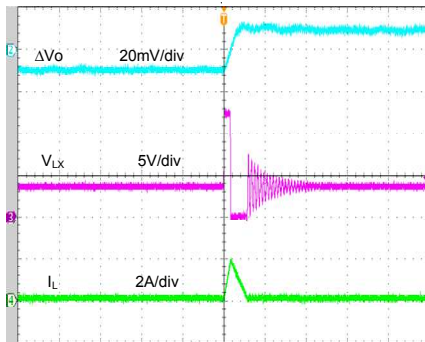

Time (2μs/div)

Output Ripple

($V_{IN}=12V$, $V_O=3.3V$, $I_O=0A$, MODE=High)

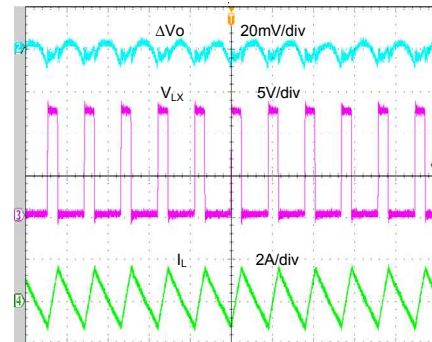

Time (2μs/div)

Output Ripple

($V_{IN}=12V$, $V_O=3.3V$, $I_O=3A$)

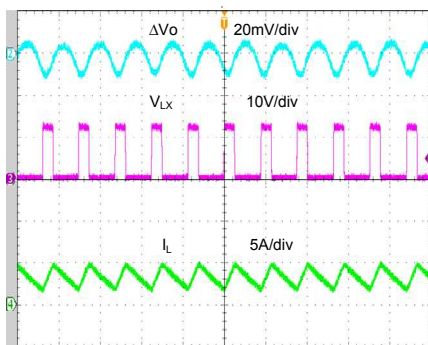

Time (2μs/div)

Output Ripple

($V_{IN}=12V$, $V_O=3.3V$, $I_O=6A$)

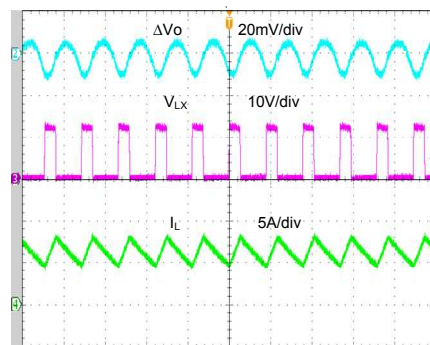

Time (2μs/div)



Startup from V_{IN}
($V_{IN}=12V$, $V_{OUT}=3.3V$, $I_O=6A$)

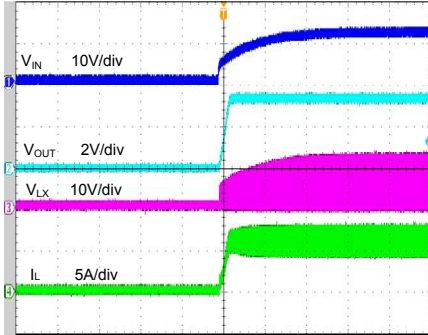

Time (4ms/div)

Shutdown from V_{IN}
($V_{IN}=12V$, $V_{OUT}=3.3V$, $I_O=6A$)

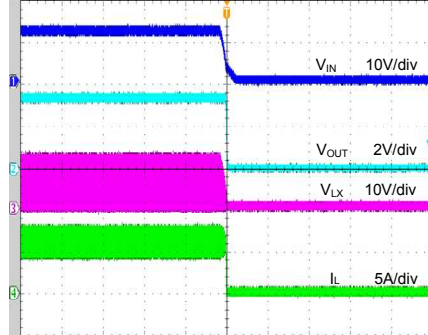

Time (4ms/div)

Startup from Enable
($V_{IN}=12V$, $V_{OUT}=3.3V$, $I_O=6A$)

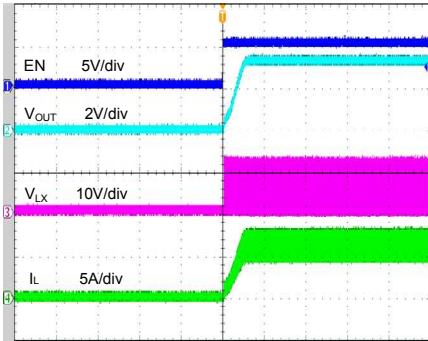

Time (2ms/div)

Shutdown from Enable
($V_{IN}=12V$, $V_{OUT}=3.3V$, $I_O=6A$)

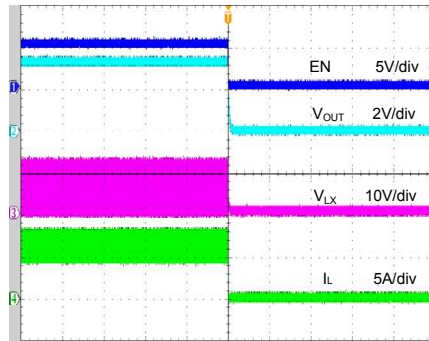

Time (2ms/div)

Short Circuit Protection

($V_{IN}=12V$, $V_{OUT}=3.3V$, $I_O=0A \sim$ Short, ILMT: Pull Low)

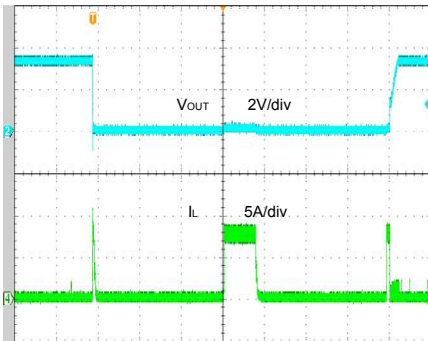

Time (4ms/div)

Short Circuit Protection

($V_{IN}=12V$, $V_{OUT}=3.3V$, $I_O=6A \sim$ Short, ILMT: Pull Low)

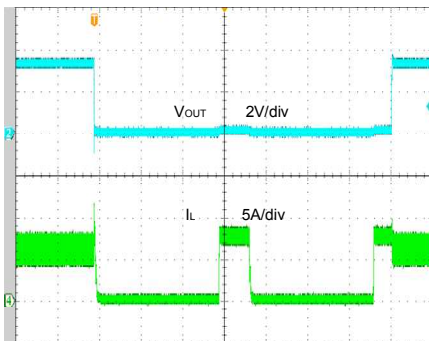

Time (4ms/div)

Short Circuit Protection

($V_{IN}=12V$, $V_{OUT}=3.3V$, $I_O=0A$ ~ Short, ILMT: Floating)

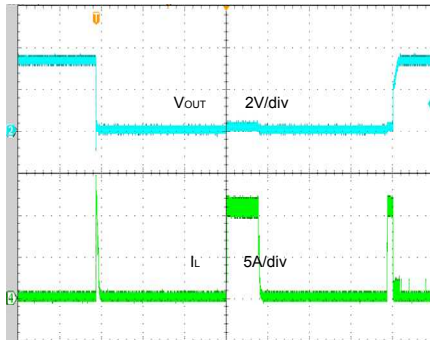

Time (4ms/div)

Short Circuit Protection

($V_{IN}=12V$, $V_{OUT}=3.3V$, $I_O=6A$ ~ Short, ILMT: Floating)

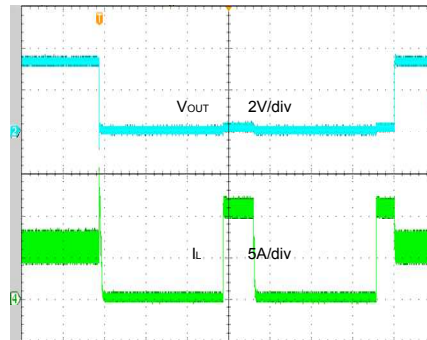

Time (4ms/div)

Short Circuit Protection

($V_{IN}=12V$, $V_{OUT}=3.3V$, $I_O=0A$ ~ Short, ILMT: Pull High)

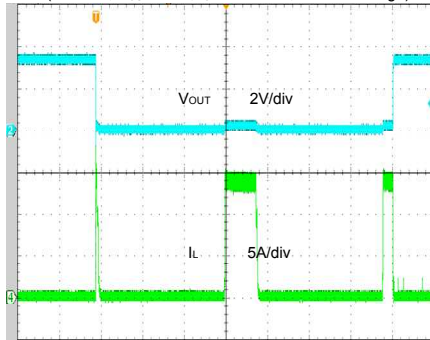

Time (4ms/div)

Short Circuit Protection

($V_{IN}=12V$, $V_{OUT}=3.3V$, $I_O=6A$ ~ Short, ILMT: Pull High)

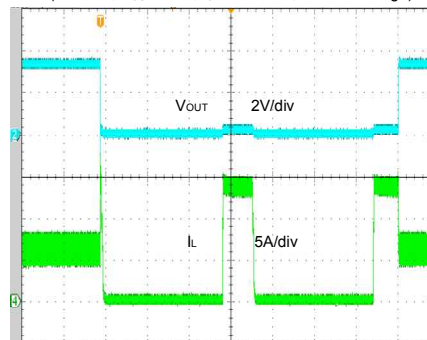

Time (4ms/div)

Operation

The SY8286A develops a high efficiency synchronous step-down DC-DC regulator capable of delivering 6A current. The device integrates main switch and synchronous switch with very low $R_{DS(ON)}$ to minimize the conduction loss.

The SY8286A operates over a wide input voltage range from 4V to 23V. The DC-DC regulator adopts the instant PWM architecture to achieve fast transient responses for high step down applications and high efficiency at light load. The device provides various protection features for reliable operation. In addition, it operates at pseudo-constant frequency of 600kHz to minimize the size of inductor and capacitor.

Applications Information

Because of the high integration in the SY8286A IC, the application circuit based on this regulator IC is rather simple. Only input capacitor C_{IN} , output capacitor C_{OUT} , output inductor L and feedback resistors (R_1 and R_2) need to be selected for the targeted applications specifications.

Feedback resistor dividers R_1 and R_2 :

Choose R_1 and R_2 to program the proper output voltage. To minimize the power consumption under light load, it is desirable to choose large resistance values for both R_1 and R_2 . A value of between 10k Ω and 1M Ω is highly recommended for both resistors. If V_{out} is 1.2V, $R_1=100k$ is chosen, then using following equation, R_2 can be calculated to be 100k Ω :

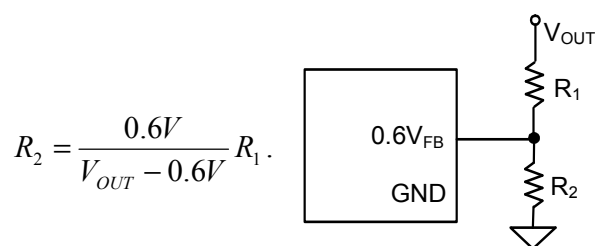

Input capacitor C_{IN} :

The ripple current through input capacitor is calculated as:

$$I_{CIN_RMS} = I_{OUT} \cdot \sqrt{D(1-D)}$$

To minimize the potential noise problem, place a typical X5R or better grade ceramic capacitor really close to the IN and GND pins. Care should be taken to minimize the loop area formed by C_{IN} , and IN/GND

pins. In this case, a 10uF low ESR ceramic capacitor is recommended.

Output capacitor C_{OUT} :

The output capacitor is selected to handle the output ripple noise requirements. Both steady state ripple and transient requirements must be taken into consideration when selecting this capacitor. For most applications, an X5R or better grade ceramic capacitor greater than 66uF capacitance can work well. The capacitance derating with DC voltage must be considered.

Output inductor L :

There are several considerations in choosing this inductor.

- 1) Choose the inductance to provide the desired ripple current. It is suggested to choose the ripple current to be about 40% of the maximum output current. The inductance is calculated as:

$$L = \frac{V_{OUT}(1 - V_{OUT}/V_{IN,MAX})}{F_{SW} \times I_{OUT,MAX} \times 40\%}$$

where F_{sw} is the switching frequency and $I_{OUT,MAX}$ is the maximum load current.

The SY8286A regulator IC is quite tolerant of different ripple current amplitude. Consequently, the final choice of inductance can be slightly off the calculation value without significantly impacting the performance.

- 2) The saturation current rating of the inductor must be selected to be greater than the peak inductor current under full load conditions.

$$I_{SAT, MIN} > I_{OUT, MAX} + \frac{V_{OUT}(1 - V_{OUT}/V_{IN,MAX})}{2 \cdot F_{SW} \cdot L}$$

- 3) The DCR of the inductor and the core loss at the switching frequency must be low enough to achieve the desired efficiency requirement. It is desirable to choose an inductor with $DCR < 10m\Omega$ to achieve a good overall efficiency.

Current limit setting

The SY8286A features both cycle by cycle peak and valley current limit. The high side MOSFET is turned off and low side MOSFET is turned on when peak current limit is triggered. When the valley current limit is triggered, the device will not allow high side MOSFET turning on until the valley current drops below the threshold. The valley current limit threshold is selectable by pulling ILMT pin low, high or leaves it floating.

Soft-start

The SY8286A has a built-in soft-start to control the output voltage ramp up speed during start up to limit the input inrush current. The typical soft-start time is 1.3ms.

Enable Operation

Pulling the EN pin low will shut down the device. During shutdown mode, the SY8286A shutdown current drops to lower than 10uA, Driving the EN pin high will turn on the IC again.

External Bootstrap Cap

This capacitor provides the gate driver voltage for internal high side MOSEFET. A 100nF low ESR ceramic capacitor connected between BS pin and LX pin is recommended.

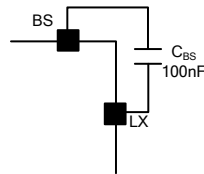

VCC LDO and BYP Input

The 3.3V VCC LDO provides the power supply for internal control and drive circuit. Bypass this pin to ground with a 2.2uF ceramic capacitor. The control and drive circuit can also be powered by external 3.3V power supply. When a 3.3V external power supply is connected to the BYP pin, the VCC LDO is turned off and the switch between BYP and VCC is turned on. The overall efficiency may be improved by connecting the BYP pin to external 3.3V switching power supply. Leave BYP pin floating if this feature is not used.

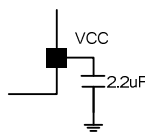

Power Good Indication

PG is an open-drain output pin. This pin will pull to ground if output voltage is lower than 90% or higher than 120% of regulation voltage. Otherwise this pin will go to a high impedance state.

Light Load Operation Mode Selection

PFM or PWM light load operation is selected by MODE pin. Pull MODE pin low for PFM operation, and pull this pin high for PWM operation.

Load Transient Considerations:

The SY8286A regulator IC adopts the instant PWM architecture to achieve good stability and fast transient responses. In applications with high step load current, adding an RC network R_{FF} and C_{FF} parallel with R_1 may further speed up the load transient responses.

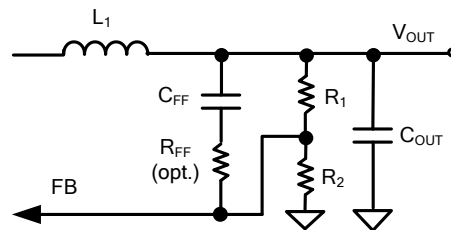

Layout Design:

The layout design of SY8286A regulator is relatively simple. For the best efficiency and minimum noise problem, we should place the following components close to the IC: C_{IN} , C_{VCC} , L, R_1 and R_2 .

- 1) It is desirable to maximize the PCB copper area connecting to GND pin to achieve the best thermal and noise performance. If the board space allowed, a ground plane is highly desirable.
- 2) C_{IN} must be close to Pins IN and GND. The loop area formed by C_{IN} and GND must be minimized.
- 3) The PCB copper area associated with LX pin must be minimized to avoid the potential noise problem.
- 4) The components R_1 and R_2 , and the trace connecting to the FB pin must NOT be adjacent to the LX net on the PCB layout to avoid the noise problem.
- 5) If the system chip interfacing with the EN pin has a high impedance state at shutdown mode and the IN pin is connected directly to a power source such as a Li-Ion battery. A $1M\Omega$ pull down resistor should be placed between the enable pin and GND pins to prevent the noise from falsely turning on the regulator at shutdown mode.

PCB Layout Suggestion

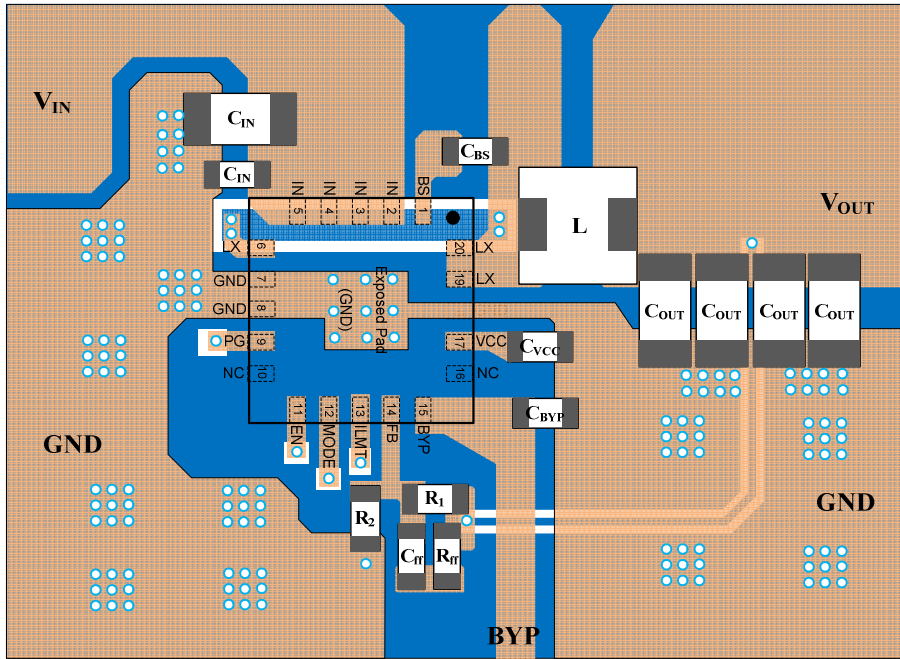

QFN3x3-20 Package Outline

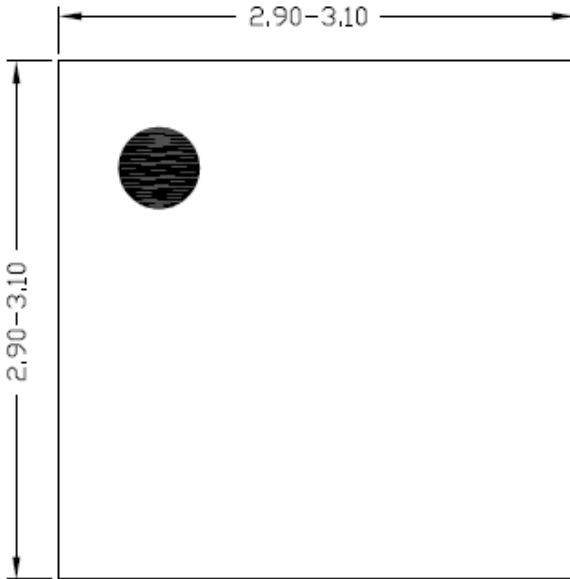

Top view

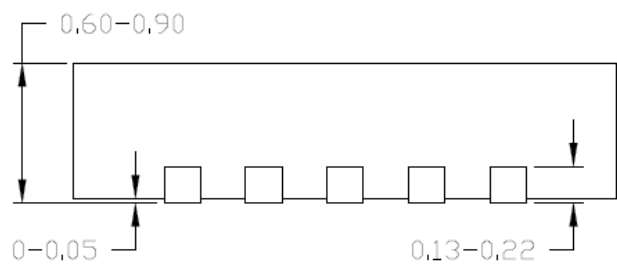

Side view

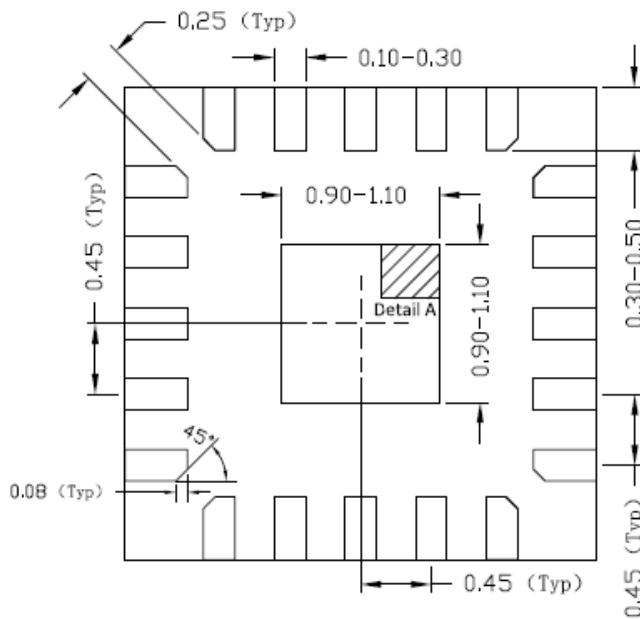

Bottom view

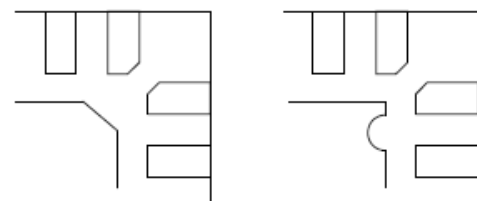

Detail A
Pin1 Identifier: two options

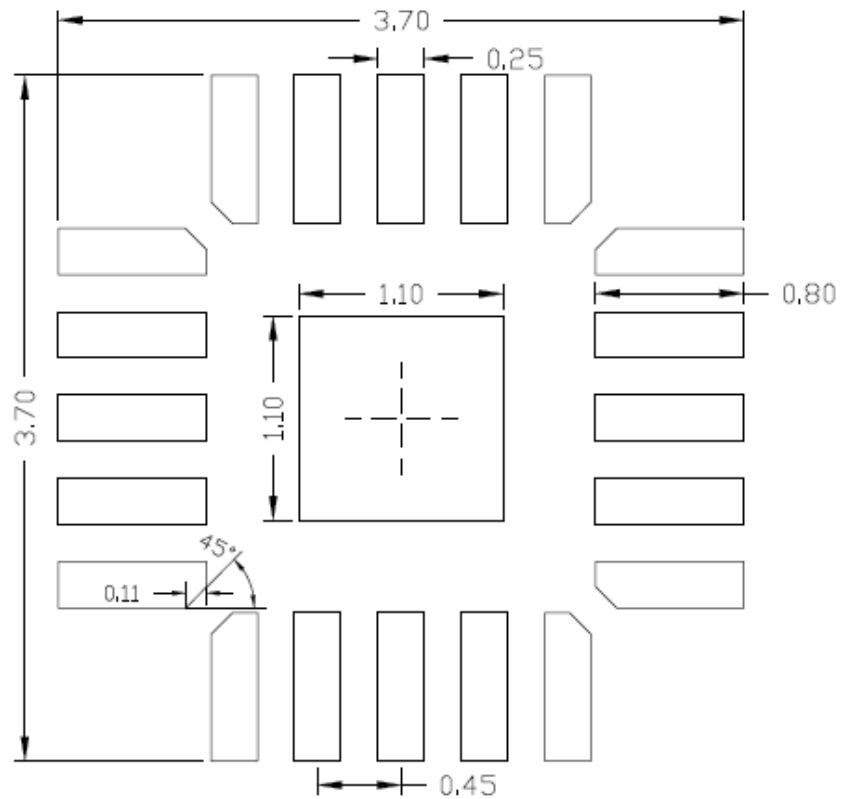

**Recommended PCB layout
(Reference only)**

Notes: All dimension in millimeter and exclude mold flash & metal burr.

Taping & Reel Specification

1. QFN3x3-20 taping orientation

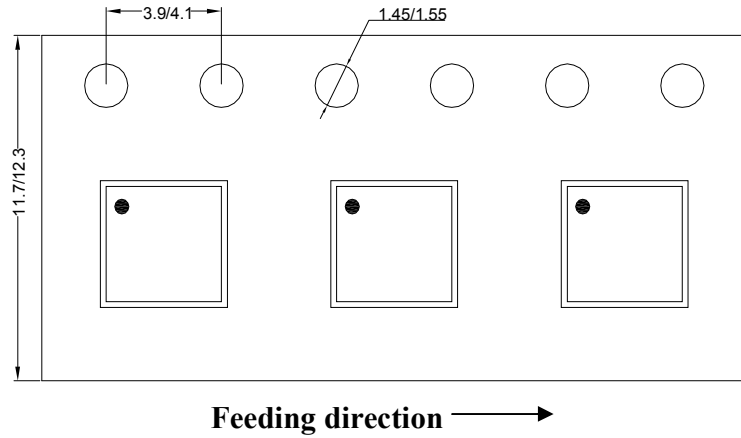

2. Carrier Tape & Reel specification for packages

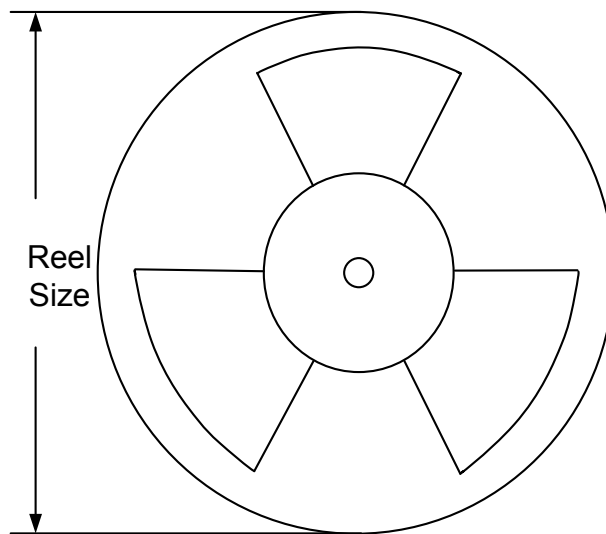

Package type	Tape width (mm)	Pocket pitch(mm)	Reel size (Inch)	Trailer length(mm)	Leader length (mm)	Qty per reel
QFN3x3	12	8	13"	400	400	5000

3. Others: NA